

USER GUIDE FOR NETmc MARINE DVR Systems



DVR Inspector



DVRi Peli



Rev 5.1, Firmware 4.3.18
May 2009

Table of Contents

1. Introduction.....	3
2. System Description.....	4
2.1 DVR Inspector. Hardware Description and Connections.....	4
2.2 DVRi Peli. Hardware Description and Connections.....	5
2.3 Installation of Inspector with removable drive.....	6
2.4 To Power-down the DVR Inspector/ DVRi Peli.....	6
3. Operating Instructions	7
3.1 Start-up	7
3.2 LCD Screen Display (not applicable to DVRi Peli)	8
3.3 Main Controls	9
3.3.1 Black Box Recording.....	10
3.4 Set-up Page	11
3.5 Making a Recording	15
3.6 Replaying the data	17
3.6.1 Using Windows Media Player™	17
3.6.2 Using the NETmc Player	17
4. FAQs	20
5. How to contact NETmc Marine Support	21
Appendix i : Technical Specifications	23
Appendix ii: Definitions & Abbreviations.....	24
Appendix iii: Keyboard short cut	25
Appendix iv: COABIS Interfacing	26
Appendix v: Recording to a networked Server / NAS	30
Appendix vi: mediaNET despatcher settings.....	31
Appendix vii: Real time file duplication.....	32
Appendix viii: Example Coabis interfacing diagrams	33
Appendix ix: Integrated Overlay configuration.....	36
Appendix x: Units with SDI input	40

NETmc Marine Ltd
Turfhill, New Deer, Aberdeenshire
AB53 6TL, U.K.
TEL. +44 1771 644001
FAX. +44 1771 644005
Email: support@netmcmarine.co.uk

1. Introduction

NETmc Marine has been designing and manufacturing digital video recorders (DVR) since the late 1990s. The DVR Inspector range, which includes the portable DVRi Peli, is its top of the range single channel recorder specifically designed for the offshore survey, ROV and commercial diving markets.

The DVR Inspector is designed to encode standard composite video signals, either PAL or NTSC, in to fully compliant MPEG 1 or MPEG 2 digital video files. These single channel DVRs are robust, simple to use, rack mountable and have a proven track record of reliability. Audio can be included in the video files by plugging a microphone into the appropriate socket on the rear of the unit. The complete video file is then stored directly to hard drive; the hard drive can be the internal drive, an attached drive or, when available, the removable SATA drive. As the units are all fitted with USB and network connections, the external drive can use either of these modes of connection.

The quality of the video files is selectable in the setup screen, where the required format (MPEG 1 or 2) and bit rate (1-6 Mbps) can be chosen.

For those users requiring more portability, NETmc Marine supplies the DVRi Peli – a single channel portable, robust unit which incorporates a built-in high resolution monitor, keyboard and mouse. DVRi Peli units are ideal for diver or mini ROV operations.

NETmc Marine's range of equipment also includes a variant of the DVR Inspector designed to accept an HD SDI signal from the new HD cameras that are now becoming available. This unit converts the HD signal to SD MPEG: in this way the ROV pilot sees the high definition picture, but the size of the video files created is the same as with standard composite, ensuring that the files are readily transferable / playable on any PC. However, as the signal going to the encoder is so good, the image at SD MPEG is far better than with a composite input.

All of the products in this range can be used as stand-alone recorders. The controls are simple and operation could not be easier. However, it is when these products are integrated with external software packages, such as Coabis, Scope or E-Inspect, that their flexibility becomes apparent. Such software packages turn the DVR Inspector range of products into high level inspection tools, where file naming, selection of storage location and control of the recorder are all done remotely over a network.

Digital video recording is fast becoming the industry standard for video acquisition and the DVR Inspector range of products is now the DVR of choice for many oil companies and inspection companies for the production of integrated video and data in the structural integrity monitoring market.

2. System Description

2.1 DVR Inspector. Hardware Description and Connections

The DVRi is a single channel rack mountable recorder running on a Windows platform. It is housed in 2U high casing and encompasses a removable hard disk drive accessed via the front panel; other hard drive options are available. All connections to the recorder are on the rear panel as shown below, as is the on/off button for the internal power supply unit and the cooling fan outlet. The power supply switch must be in the on (1) position for the recorder to function; it is good practice, but not essential, to switch the internal power supply off when the recorder is not in use.

On the front panel of the recorder is found the main ON button, the receptacle (where fitted) for the removable drive and a small LCD screen beside which there are 4 black buttons, these buttons are for the control of the menus that are displayed on the screen. These screens are primarily displaying status indicators and so, under normal circumstances, the operator need not concern themselves with them.

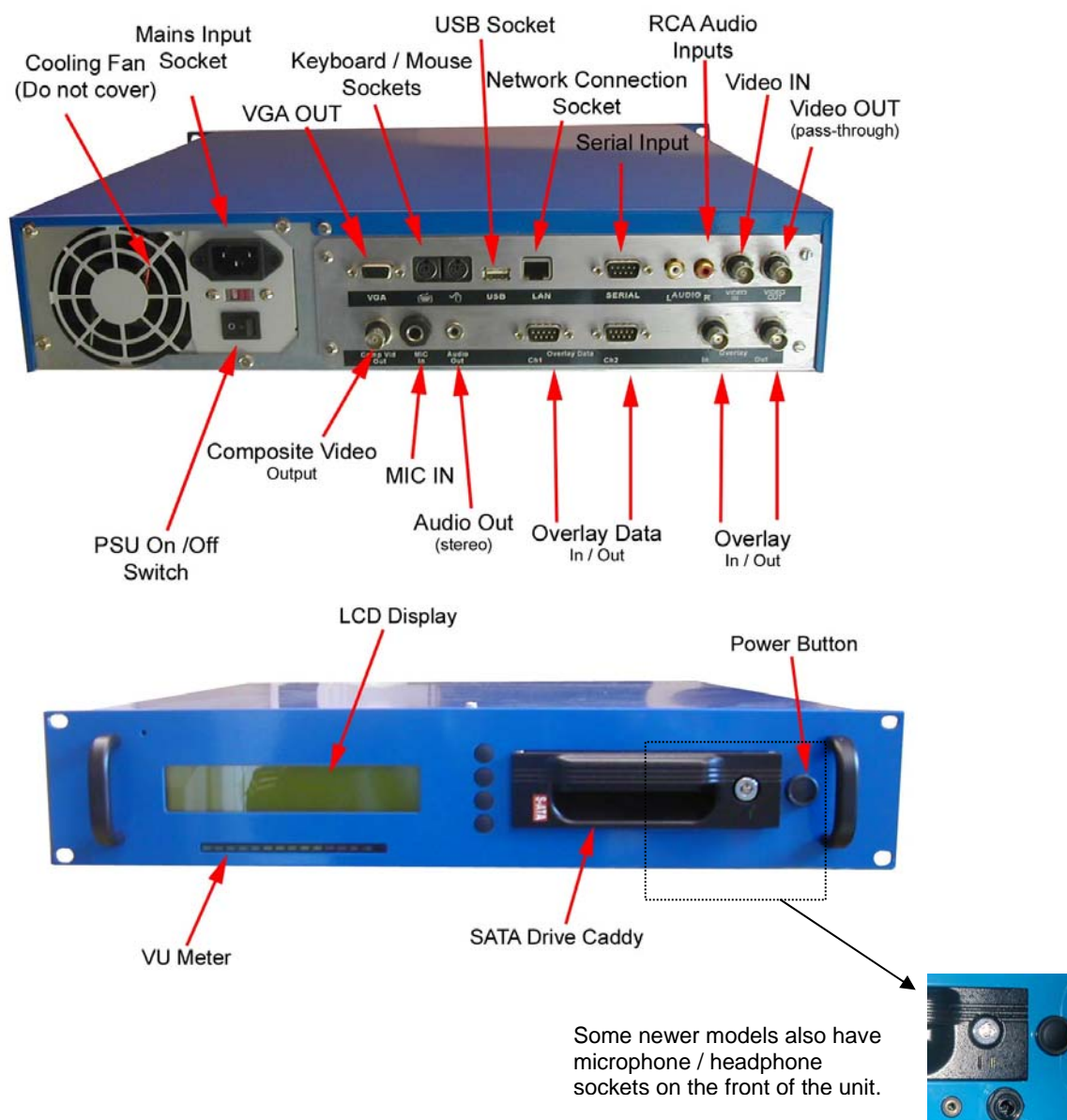

2.2 DVRi Peli. Hardware Description and Connections

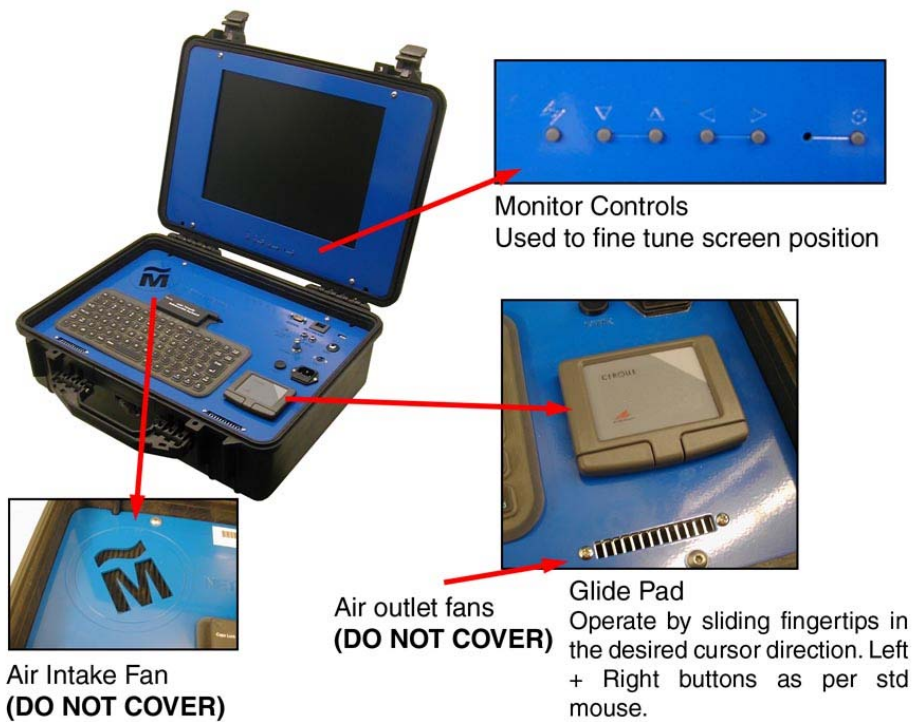
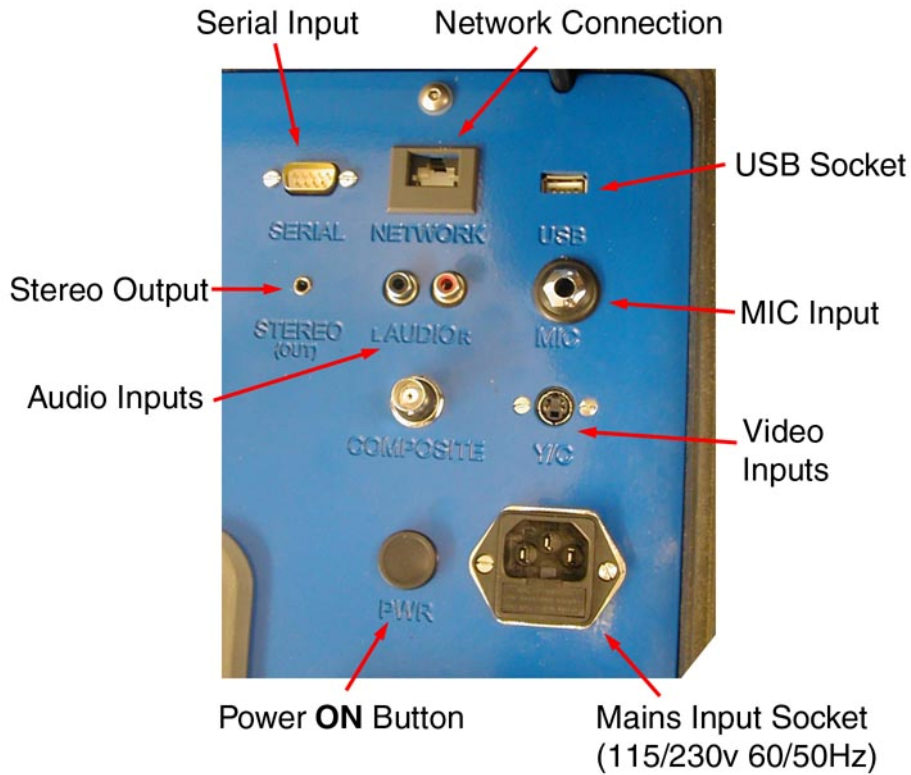

Please ensure that no cables etc have been left on the surface of the DVRi Peli before closing the lid, as this could damage the monitor.

2.3 Installation of Inspector with removable drive

1. Install the DVRi in a 19" rack giving consideration to the height at which the unit is mounted to facilitate the easy removal of the hard drive.
Note1: It is essential that sufficient space be allowed behind the recorder to allow the power supply-cooling fan to function correctly.
Note2: If networking the DVRi, all network connections must be made and the network be **live** before switching on the DVRi, otherwise no streaming video will be available.
2. If the video signal is first being routed via a composite monitor, ensure the impedance switch on the monitor is set to **open**, otherwise no picture will be seen on the DVRi screen.
3. Make all the necessary connections at the rear of the recorder, including power cable, keyboard and mouse; the required connections will vary depending on the video signal being input, display devices being used etc.
4. Switch on power supply at rear of recorder, position 1.
5. Insert a hard drive in to the receptacle at the front of the machine. Do this GENTLY. Although the drives are 'Hot Swappable' we advise that drives are only inserted or removed when unit is powered OFF.
6. Press the "power on" button on the front panel. The two LEDs on the front of the removable drives should be on. The Green LED is a power indicator and the Red LED is a status indicator for the fan, if the Red LED is on the fan is OK, if it is blinking then the fan is not working correctly.

Note: This is **not** a "power off" switch.

7. Install the DVRi in a 19" rack giving consideration to the height at which the unit is mounted

2.4 To Power-down the DVR Inspector/ DVRi Peli

- Close all desktop applications
- Click START from the Windows Tool Bar
- Select SHUTDOWN
- With Shutdown selected, click OK

This will close Windows and switch off the PSU

DO NOT REMOVE MAINS CONNECTION BEFORE SHUTDOWN

3 Operating Instructions

3.1 Start-up

The DVR-Inspector software runs on a Windows 2000 or XP professional installation. The software suite will start automatically upon system boot. If for any reason this does not happen, or if the software has been closed down by a previous user, the application can be launched by double clicking the NETmc, DVR-Inspector icon on the desktop:



Windows Desktop

On initial power-up, the software will display the message below.

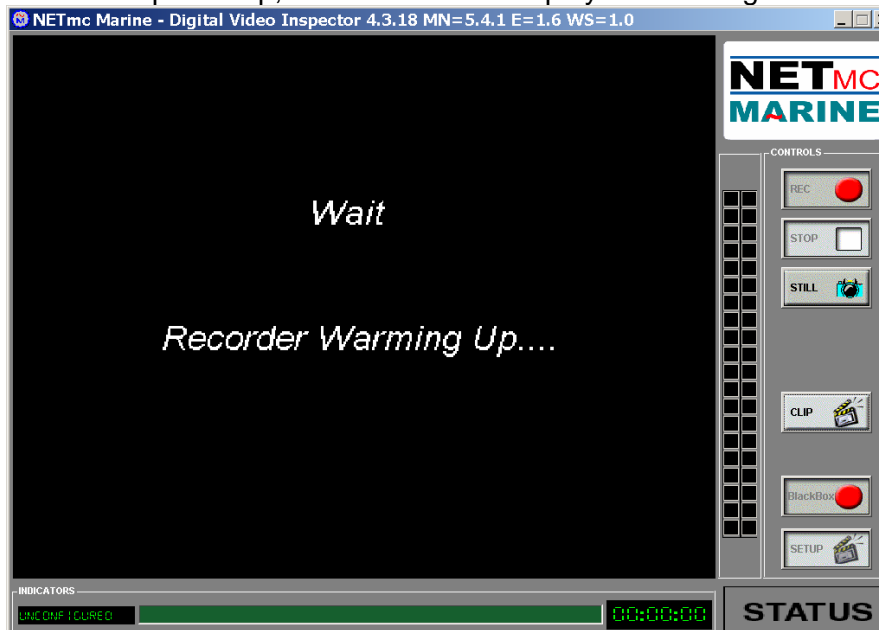

Splash screen

3.2 LCD Screen Display (not applicable to DVRi Peli)

This display on the small LCD screen on the front panel of the DVR Inspector also updates as the unit powers up.

First displayed is an initial screen containing NETmc Marine's contact details:

```
NETmc Marine Digital Media Products
(W) WWW.NETmcMarine.co.uk
(E) Support@NETmcMarine.co.uk
S: 020100000000038 T:DVR M:Inspector
```

As the operating system kicks in, and Windows comes alive, the display goes through the following stages:

```
Inspector v437 19/08/08 16:07:25 | MENU
ENC=CLOSED | MORE
SVR MODE NOT AVAILABLE |
UDP=CL FILE=CL NAV=A TCP=WT |
```

```
Inspector v437 19/08/08 16:07:38 | MENU
ENC=AUTO STARTING | MORE
SVR MODE NOT AVAILABLE |
UDP=CL FILE=CL NAV=A TCP=WT |
```

As soon as the unit is fully functioning, the 2nd line of the display shows ENC = and digits that are incrementing.

```
Inspector v437 19/08/08 16:07:31 | MENU
ENC=00:01:14 | MORE
CLOSED |
UDP=CL FILE=CL NAV=A TCP=WT |
```

NOTE: This is a useful indicator if you any problems occur with your DVR Inspector. If the 2nd line is frozen or shows ENC = any other text, it suggests that the underlying encoder system has become upset. Please note down the text and contact NETmc Marine Support as described in Section 5 below.

3.3 Main Controls

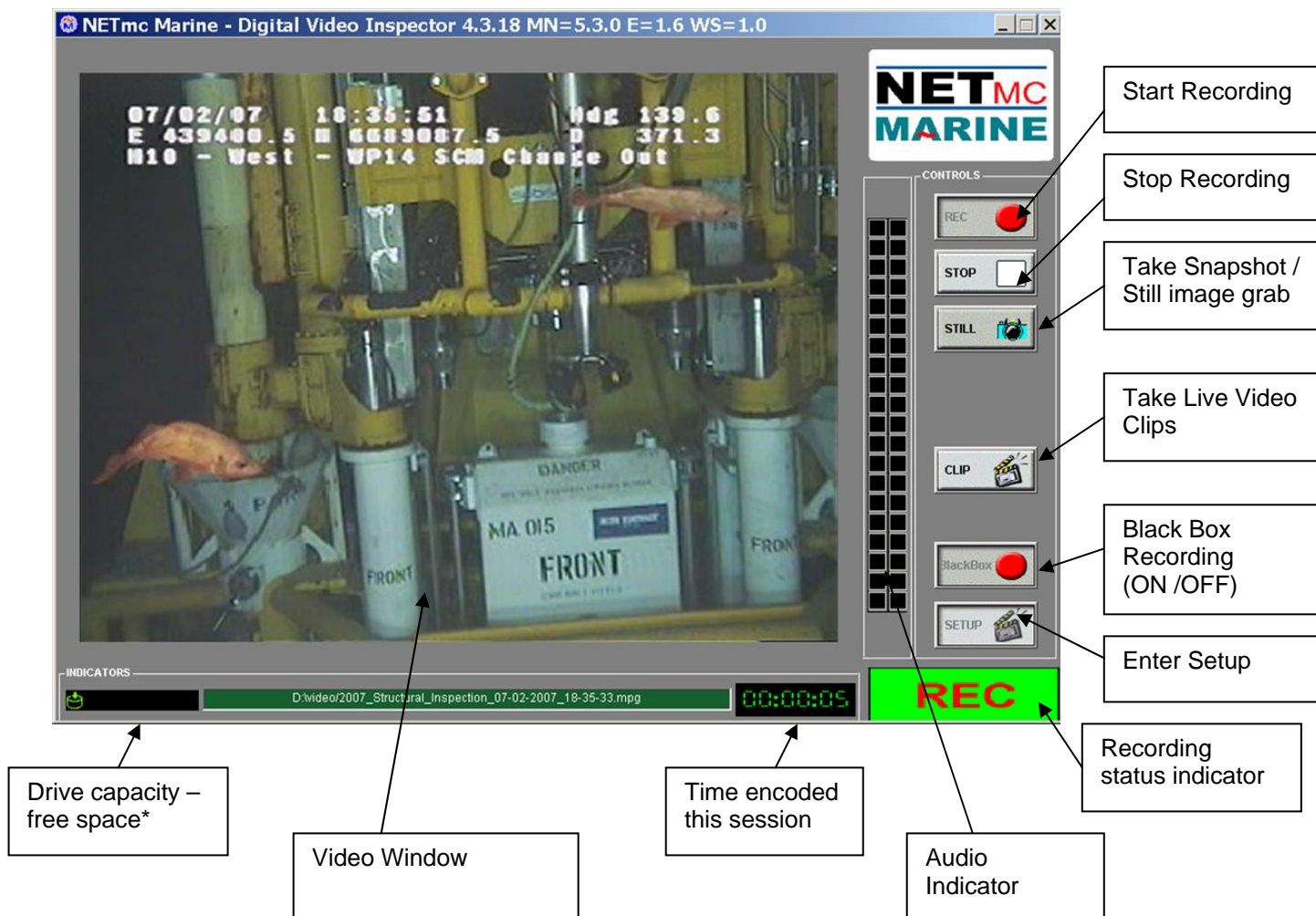

Once the program has started, the operation controls are displayed. From here the user can start and stop recording, take still images (snapshots) and/ or video clips and enter the set-up screen.



* Drive Capacity

Note that this display changes colour according to how much disk space is free:

The display is:

- Green if more than 25% of the disk is free. 
- Orange if between 10% and 25% of the disk is free
- Red if less than 10% of the disk is free. 

3.3.1 Black Box Recording

Black box recording is an optional extra. This option allows a separate, continuous recording of the whole operation, for example for health and safety purposes, independent of whether the video is currently recording. This button will only be enabled if you have purchased the Black Box option.

The following images indicate whether the Black Box is enabled or not:



ENABLED



DISABLED

Recording

If the Black Box option is enabled, clicking on this button will start recording. The button will now look like this:



The presence of a green tick in the status bar is also necessary for Black Box recording. This indicates that the housekeeping system is functioning, whereby old files are deleted to make way for new ones, enabling continuous recording. If no green tick is present, the disk will eventually become full and recording will stop.

Unless otherwise arranged, the Black Box will record to a separate 120 gigabyte hard disk drive called the D: Drive. Depending on the quality settings chosen, the Black Box allows continuous recording for between 33 hours (highest quality settings) and 213 hours (lowest quality settings.)

Black Box files are automatically saved under the time and date recorded and can be accessed through Windows.

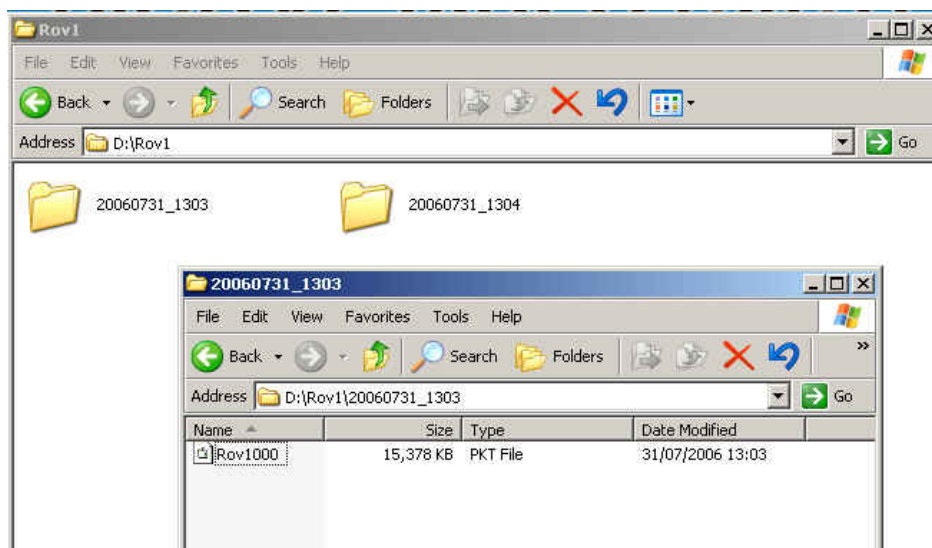

3.4 Set-up Page

After clicking the SETUP button you will see the following screen. Here you can configure the recorder; setting the video format and compression rate, the length or size of the video files (PKTS) and allocating the storage path and file names.

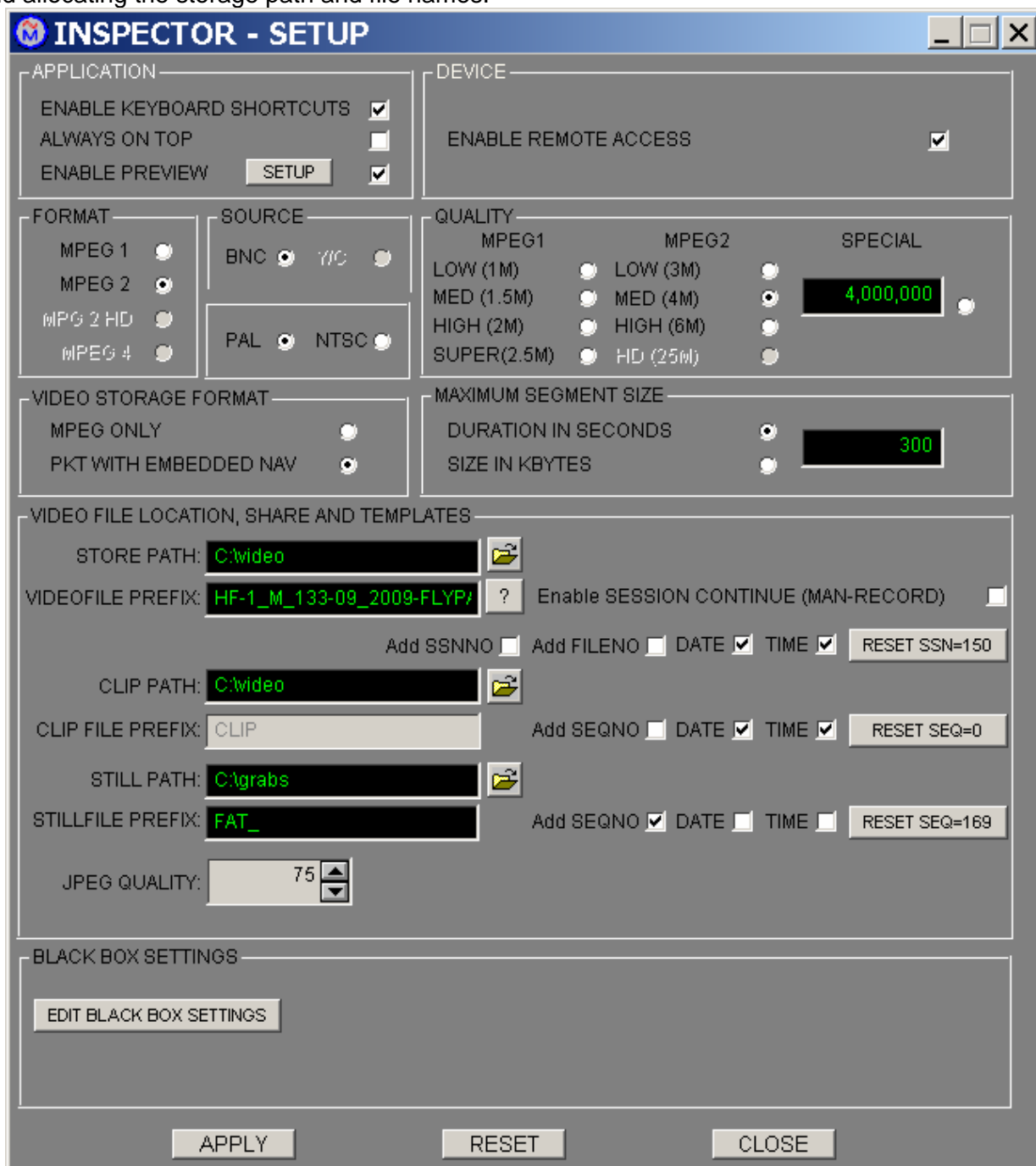

NOTE: Units with SDI input have a different set-up page (see Appendix xi)

The set-up settings of the DVRi can be changed, however the unit will have been shipped from the factory configured with the optimal settings for your application– it is recommended that these be left as shown above (settings for MPEG1) or at least a note is made of them to enable the unit to be configured as it was when it left the factory.

A description of each parameter in the set-up screen is given below:

Application:

- Enable keyboard Shortcuts* This enables or disables the use of keyboard shortcuts. See appendix (iii) for a list of short cuts.

- Always on top* Keeps the video recorder display on top of any other windows that may be open.

- Enable Preview* Automatically starts the live video on start-up
Grey "SETUP" box this is for engineer configuration only

Device:

- Enable Remote Access* Allows network control

Format:

- MPEG1* Select to record in MPEG1 format
- MPEG2 ** Select to record in MPEG2 DVD format.
- MPG2HD** Select to record in MPEG2 high definition.
- MPEG4 ** Select to record in MPEG4.

*. These options are only available if there is a suitable encoder installed.

NOTE: The selection of the format does not just depend on the desired quality of the video; consideration should also be given to how you will view the data at a later date. For instance should you wish to view the data over the Internet then you may wish to use the lowest compression rate available.

Source:

- BNC* – Click this if video is coming in via the BNC connector on the rear panel i.e. Composite input.
- Y/C* – This option is no longer available
- PAL* – Click here if input video is in the European format PAL
- NTSC* – Click here if input video is in the American / Asian format

Quality:

This section allows the selection of bit rate – as specified in procedure or by experiment.

Video Storage Format:

- MPEG only* This setting will only record raw mpeg files

- Pkt with embedded nav*– With this option enabled, and a Navigation string being input to the recorder, each MPEG file will be tagged with positioning data, this then enables the video to be integrated in to a GIS system at a later date.
Note: For structural inspections there is no benefit to ticking this box as generally there is no acoustic positioning data available. Although certain types of software (e.g. Coabis) require the use of pkt to enable enhanced editing features.

Maximum Segment Size:

Each section of video recorded can be broken down into discreet video clips to aid reviewing and managing the files. These sizes of each clip can be set by time or volume of data. Should you wish to be able to download a file to a certain type of media e.g. a floppy disc, then you would select file size as the controlling factor and set the size to fit your disc.

If on the other hand you wish to store the video by time then select that option and put in the number of seconds you want the file to be.

The size of file chosen will depend very much on the project in hand, but should probably be no less than 5 minutes; otherwise the number of files recorded may become excessive and difficult to manage.

Video File Location, Share and Templates:

<i>Store Path</i>	This is the location that your video files will be stored. The default location is "D:\Video"
<i>Videofile Prefix</i>	Adds a chosen name or auto variable to the video file. Select "?" for a list of auto name options.
<i>Enable Session continue</i>	A session is the time between RECORD being pressed and STOP being pressed. Each time recording starts, a new session starts. By ticking the box, recording can be stopped and re-started under the same session.
<i>Add SSNO</i>	Adds an the session number to the file name each time record is pressed.
<i>Add FILNO</i>	Adds an incrementing file number to each file created.
<i>Date</i>	Adds the current date to the file name
<i>Time</i>	Adds the current time to the file name
<i>Reset SSN = 134</i>	Resets the session number to zero (in the example shown the session number is currently 134)
<i>Clip Path</i>	Select the location where video clips will be stored. The default location is "D:\Clips"
<i>Clip Path Prefix</i>	Add a chosen name/prefix to video clips.
<i>Add SEQNO, date, time</i>	Adds an incrementing number, current date and current time to the file name for video clips.
<i>Reset SEQ = 0</i>	Reset sequential numbers to zero (currently 0 in the example shown)
<i>Still Path</i>	Select the location where still image grabs will be stored. The default location is "D:\Grabs"
<i>Still File Prefix</i>	Add a chosen name/name to still image grabs.
<i>Jpeg quality</i>	Select the required quality for still image grabs.
<i>Add SEQNO, date, time</i>	Adds an incrementing number, current date and current time to the file name for video grabs
<i>Reset SEQ = 59</i>	Reset sequential numbers to zero (currently 59 in the example shown.)

Black Box Settings

If you have purchased the Black Box recording option, clicking this box enables you to modify the relevant settings.

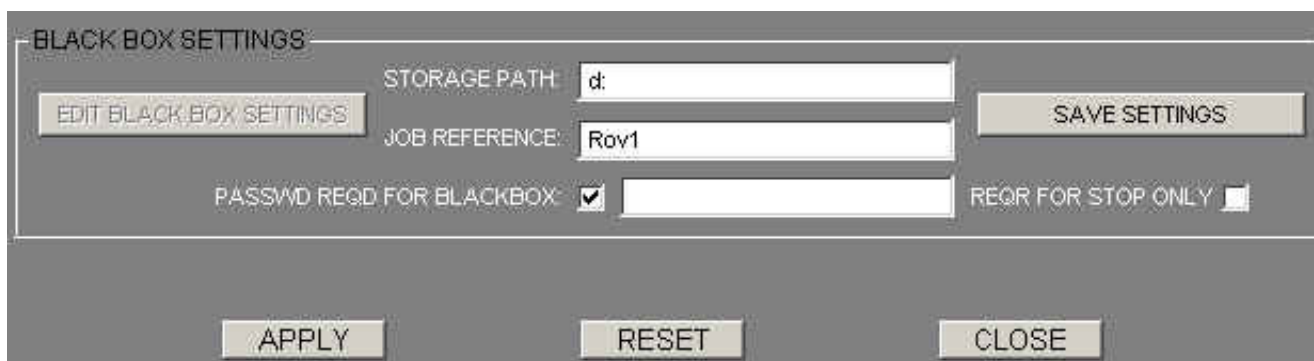

Storage Path - Unless otherwise arranged, the default storage location is the d: drive and should not be changed.

Job Reference - This would ideally refer to the general operation (e.g. diver, ROV) and not a specific task.

Password - A password can be entered here to prevent accidental switching on or off of the Black Box recording, or if the "Reqr for Stop Only" box is ticked, to prevent accidental switching-off only.

Options at bottom of Set-up Page

Apply – applies the changes

Reset – Undoes any changes you have made during the current visit to the set-up screen

Close – Closes the SETUP window

Once the system has been configured click on the "CLOSE" button to return to the main control screen where you can begin recording.

3.5 Making a Recording

Once the system is running, the software will default to ready mode.

With no video signal, the preview screen will show the following message:

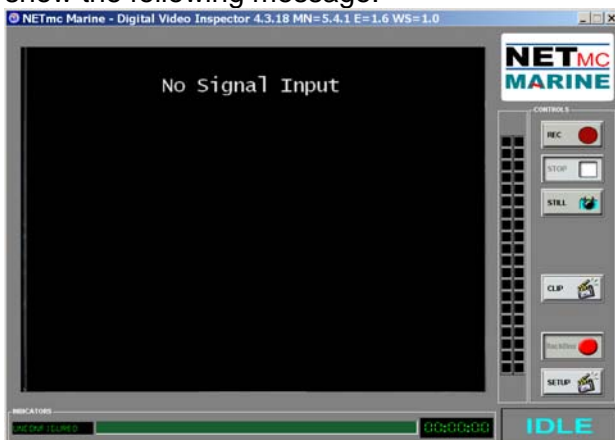

With a signal applied, the video will appear in the preview window:



To start the recording, simply click on the RECORD button.

When recording has started, the status indicator changes to "REC" instead of "IDLE", the REC button will become depressed and the minute counter will start to increment:

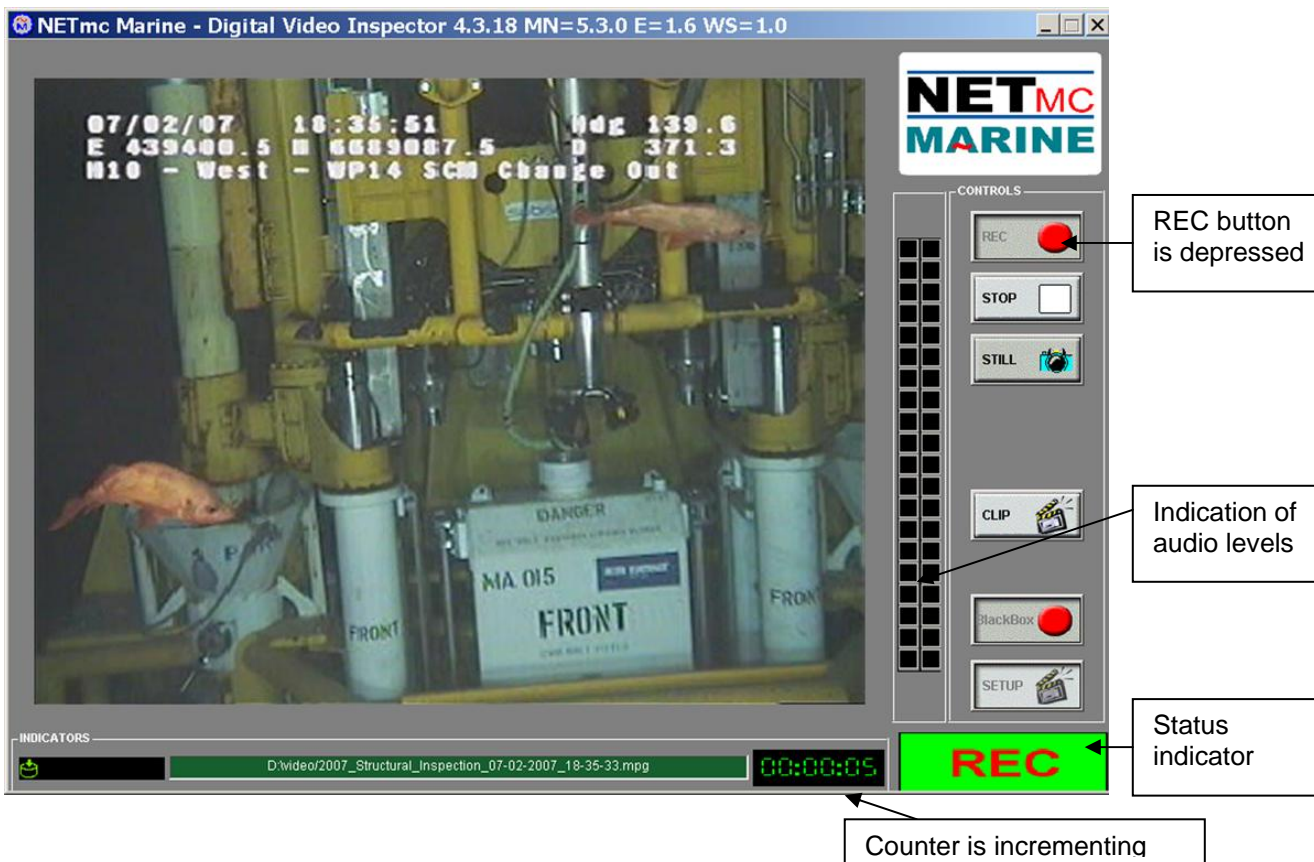

The image on the screen shows the video signal that is being input to the DVR.

Once the desired footage has been recorded, simply click on the STOP button to end recording.

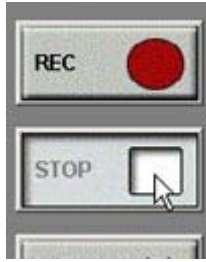

At any point during the recording or preview, the image on the screen can be saved as a jpg file by clicking the STILL button.



To resume logging, simply click the RECORD button again. The system will automatically create a new file, automatically named as per the configuration in the SETUP page.

Similarly, live video clips can be taken at any point during the recording or preview by clicking the CLIP button.



The clip will continue to grow until the CLIP button is pressed again. An incrementing timer will be displayed on the button while the clip is being recorded.

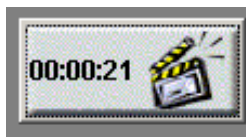

3.6 Replaying the data

3.6.1 Using Windows Media Player™

Replaying on the DVRi

- Go to the Desktop
- Click on “My computer”
- Click on the drive to which you are storing the video
- Open the video folder there
- Double click on the video file you wish to check; this will automatically open up in Windows Media Player

However, we recommend preserving the DVRi for recording only and replaying data through another channel.

Replaying via a network, NAS device, or SATA drive (USB to Sata adapter)

- Go to the Desktop
- Click on “My computer”
- Click on the drive to which you are storing the video
- Open the video folder there
- Double click on the video file you wish to check; this will automatically open up in Windows Media Player

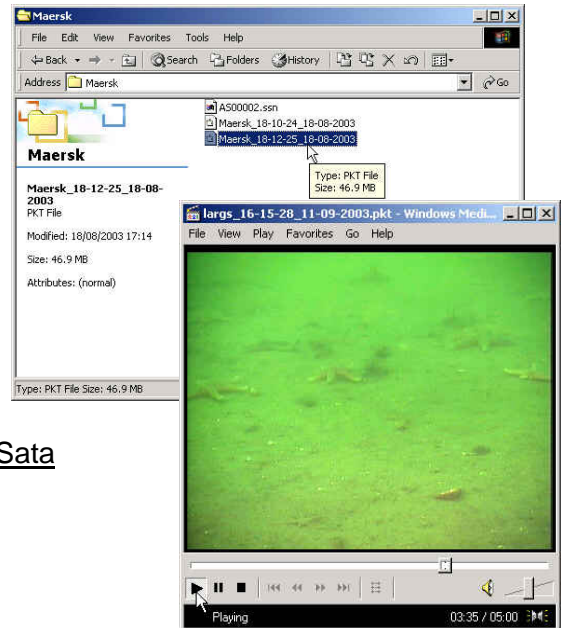

NOTE: Using Windows Media Player it will only be possible to play one video segment at a time.
NOTE2: If files were recorded in MPEG2 format, then a codec will be required. This is available to download from our website. See www.netmcmarine.co.uk/file_downloads.htm - (ElecCard is our preferred codec for viewing MPEG2 files.) **A symptom that a codec is required is a black screen - with audio but no picture.**

If the video was recorded to a removable drive you will need to insert the drive in to the USB caddie and connect this to your PC. Once the storage unit is connected to the USB port of your PC, a new drive will appear on your desktop. Follow the same options as above.

3.6.2 Using the NETmc Player

another way to view the video is with the NETmc Marine viewer –this can be downloaded from our website - see www.netmcmarine.co.uk/file_downloads.htm . Download Video Viewer and also ElecCard to view MPEG2 files.



To use the special player, click on the “3HEAD PLAYER TOOL” shortcut. (This is called the 3 head player as it can be used with our 3 channel DVR PRO as well).

You now have access to a very powerful viewer and editing software package which can play multiple contiguous files and edit across them using the “MARK IN” and “MARK OUT” buttons. This edited video can then be saved as a new file.

There is also the facility to take additional “SNAPS” during review.

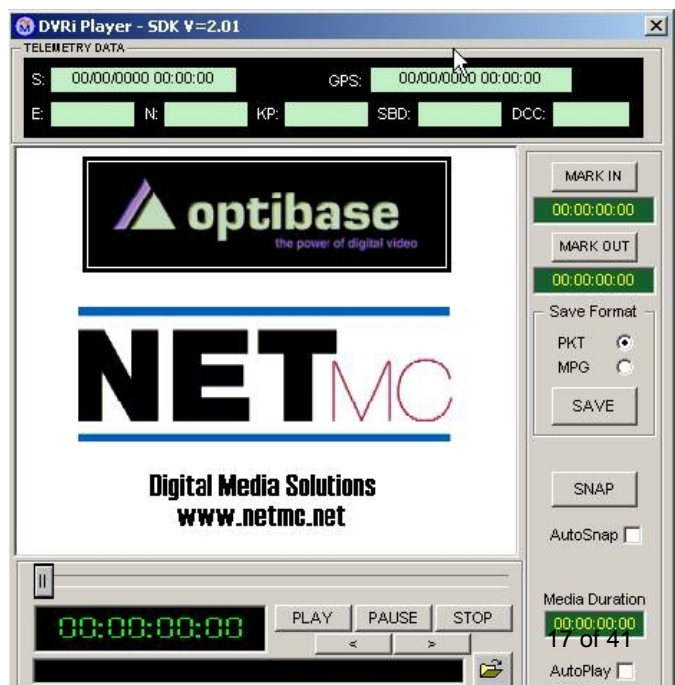

Across the top of the viewer is where navigation data is displayed, if there is any attached to the video.

To open a video file, click on  This will open an explorer style dialog box from which you can select a file to be played. To select the video file you want, highlight it and then clicking "OPEN". Another way of the selecting the file is to click on it and drag it over the 3Head viewer. When you select a video file the file name appears in the window beside the open folder icon.

If you wish to play back more than one continuous video file follow these steps;

1. Click on the first file you wish to play
2. Hold down the shift button and use the down arrow key to highlight the files you wish to play together.
3. Click and drag these files over the 3Head player.
4. Release the mouse button and the files will drop in to the player.

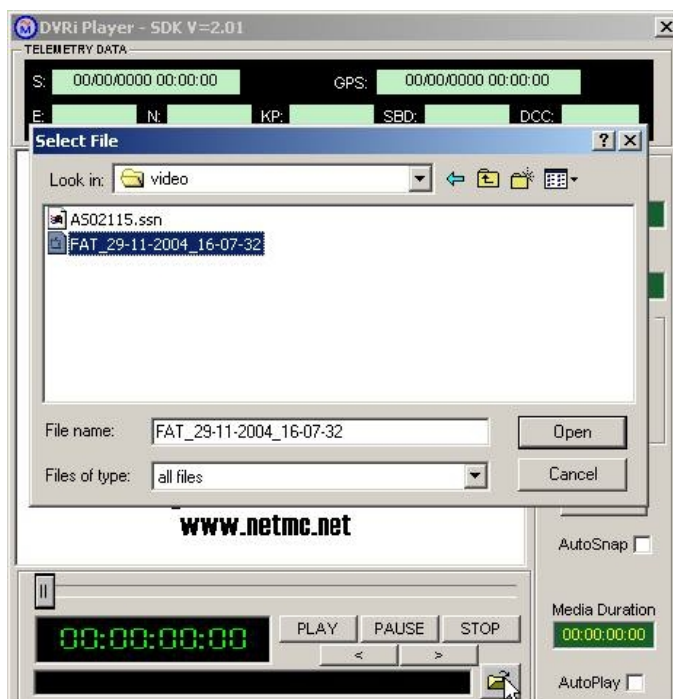

NOTE: When you select more than one file, the file name display window will display a temporary file name as it cannot display all the files being viewed.

After selecting OPEN the file manager will disappear and the player will display a black screen ready to play the video, note the file name in at the bottom of the player screen.

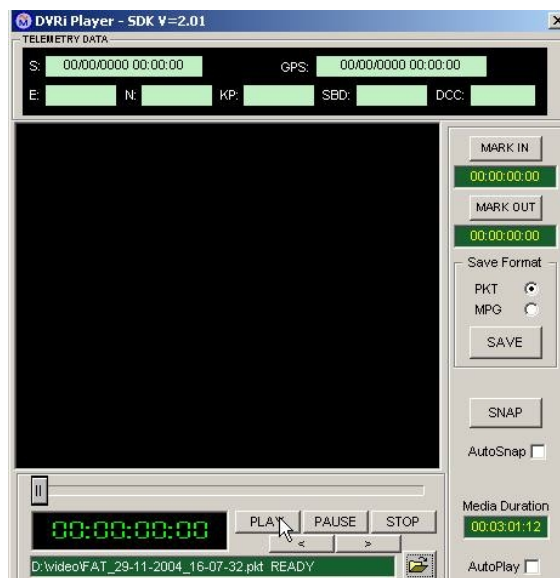

To start, stop, pause, fast forward or fast backward the video use the player controls near the bottom of the screen.



With the video playing, you will see the progression bar move along the slider. The speed that this moves depends on the size of the video file selected in the SETUP screen of the DVRi.

As the video plays you can use the editing controls to start cropping the video or just to take a still.



Here is a description of the editing controls and displays

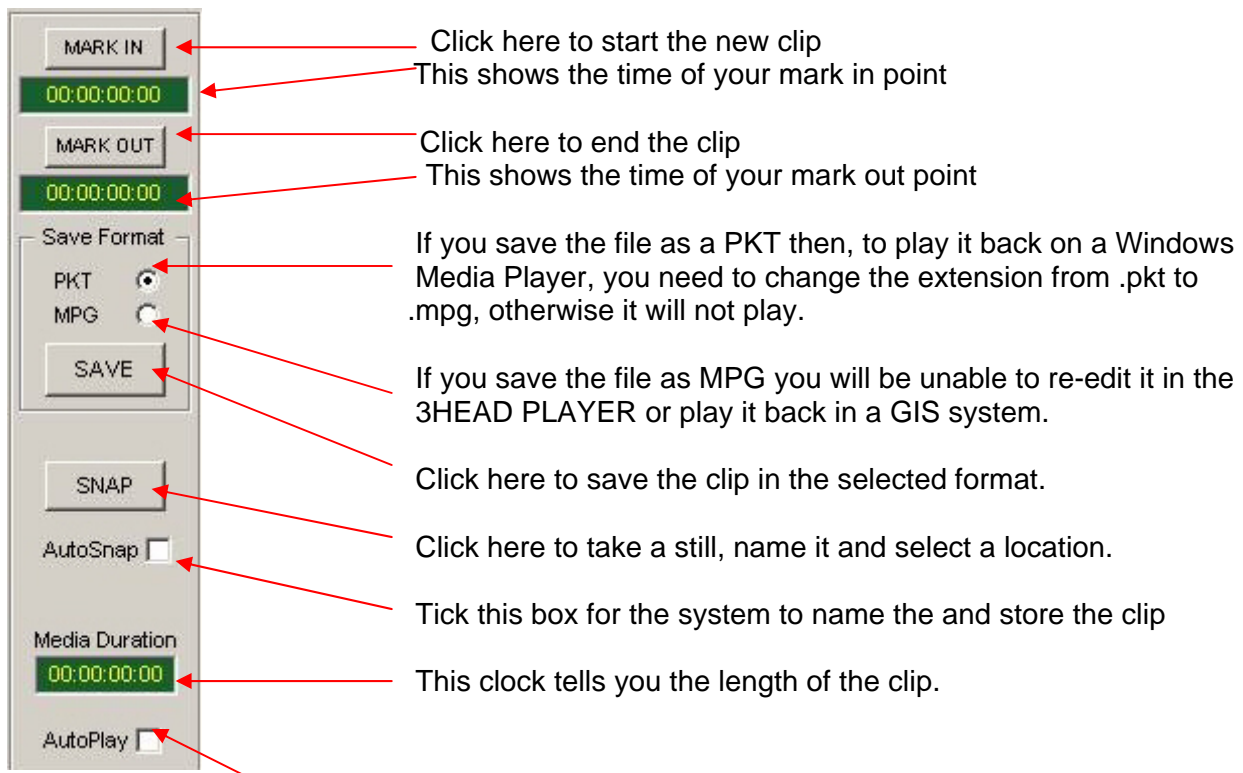

Tick this box if you want your video to start playing automatically upon selection.

4. FAQs

Q. "When the system starts – there is no picture on the screen, just green noise"

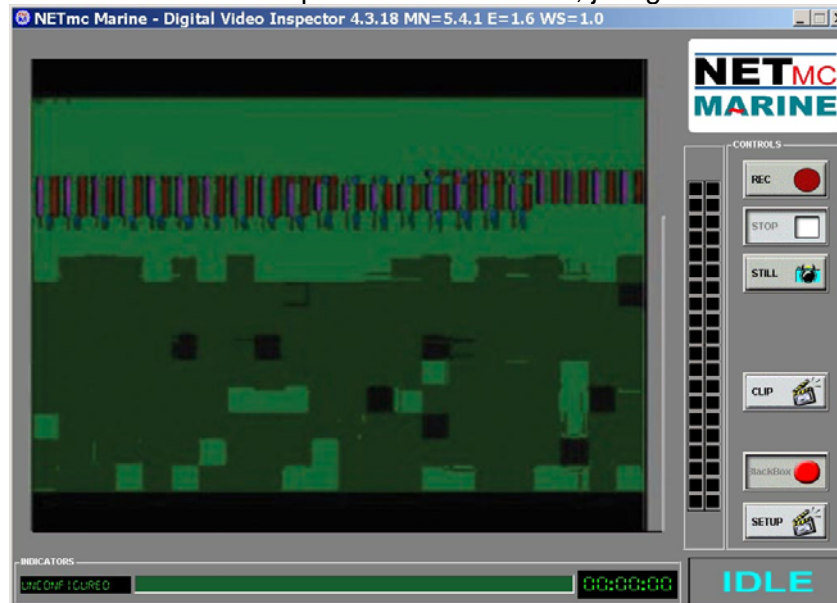

A. This is because the camera is not outputting a signal and the overlay is in circuit.

Q. The screen is completely black.

A. Check that you have not selected MPEG2 on a box that only has MPEG1 encoder installed.

Q. The viewing screen has reduced in size when I go to Windows and back again.

A. This is a Windows derived problem. Shut down the NETmc Marine application and re-launch.

Q. When I try to play back my video clips in Windows Media Player it does not play.

A. Check that the Extension to the file is mpg, if it is .pkt then change it to mpg.

Q. An error message like the one below is displayed:

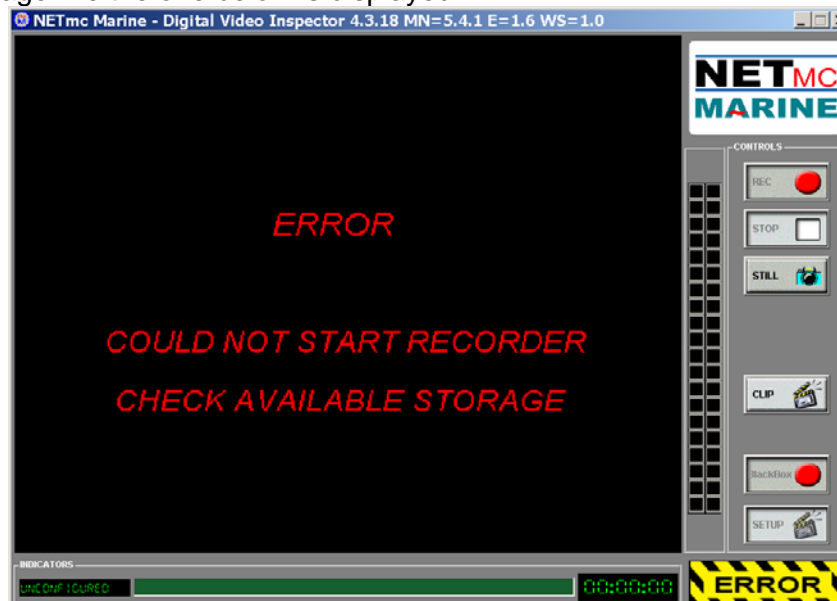

A. Check all cables and connections. If no fault can be found, please contact NETmc Marine Support (see section 5).

5. How to contact NETmc Marine Support

Should any problems occur with your *DVR Inspector or DVRi Peli* that are not addressed by this manual please contact our Support Team:

Email: support@netmcmarine.co.uk.

Tel: +44 1771 644001

Should your call be outside office hours, please leave a message on the answering machine, which will be forwarded to one of the support engineers. Although we cannot guarantee 24/7 availability, we endeavour to respond as quickly as possible to any query – regardless of when the support call is made.

In order to help our engineers solve the problem as quickly as possible, please have ready the following information:

- Type of equipment (e.g. DVR Inspector or DVRi Peli)
- Serial number (from the bar code sticker attached to the unit or IP Address)
- A description of the fault, including any information on events that happened prior to the fault that might have affected the equipment (e.g power surge on vessel, change to wiring on vessel, change to software configuration including change to username/password).

Note: Whilst every effort has been made to ensure that the information contained in this manual is accurate, no liability can be accepted for errors and omissions.

Section 6

APPENDICES

Appendix i : Technical Specifications

Power Requirements	100 - 240 Vac, 50 - 60 Hz
Power Consumption	90w
Operating Temperature	10 - 35 Degrees
Non-operating Temperature	-10 - 60 Degrees
Operating Humidity	5-95% RH non-condensing
Non-operating Humidity	5-95% RH non-condensing
Operating Shock	65G, 2ms
Non-operating Shock	250G, 2ms
Operating Altitude	-305m – 3,050m
Non-operating Altitude	-305m – 12.200m
Operating Vibration	Linear 20-300Hz, 0.75G (0 to peak) Random 10-300 Hz, 0.004g ² /Hz
Non-operating Vibration	Low frequency 5-20 Hz, 0.195 inches (double amplitude) High frequency 10-300Hz, 5.0G (0 to peak)
Dimensions	482(W) x 88.5(H) x 455(D) (2U case)
Weight	11kg
Video Input	Composite (BNC) / PAL / NTSC
Video Stream Format	MPEG1 / MPEG2
Video Rate	500 kbps - 6 Mbps
Audio	Analog stereo line input + microphone
Network Support	10 / 100 Base T

Storage and shipping

After overnight road freight the units should be left at room temperature for 24 hours before powering on.

After air freighting the units should be left at room temperature for 48 hours before powering on.

Appendix ii: Definitions & Abbreviations

Definitions

DVRi DVR Inspector Single Channel Digital Video Recorder

Abbreviations

ASCII American Standard Code International Interchange

DB Database

DLT Digital Linear Tape

DRS Digital Review Suite

DVR Digital Video Recorder

HTML Hyper Text Mark-up Language

MPG Moving Pictures Expert Group File extension for a video file

MPEG1 Industrial recording format, controlled by the Moving pictures expert group
Playable on all Windows operating systems win95 ->

PKT Packet File Extension

PAL Phase Alternation by Line – the European video format

NTSC National Television Standards Committee – American / Asian video format

JPEG Joint Photographic Experts Group

Mbps Mega bits per seconds – rate of video encoding

QC Quality Control

USB Universal Serial Bus

Store path Local on hard-disk where the video will be placed

SVHS Super Video Home System

TIFF Tagged Image File Format

Appendix iii: Keyboard short cut

<u>ShortCut Key</u>	<u>Function</u>
R	Record
S	Stop
Spacebar	Snap

Appendix iv: COABIS Interfacing

This section explains how to configure the Coabis digital video interface for the NETmc Marine DVR Inspector hardware. There are two parts to configuring the interface. First, you must connect and detect the encoder. Secondly, you must define where routine and anomalous video footage and still images are to be stored, and which applications are to be used to display the clips and images.

Hardware setup

To command a DVRi from a Coabis system you will need:

A PC to run Coabis

A network card in that PC

An IP address on your coabis machine in the same range as the DVRi

A cross-over network cable (or hub/switch and 2 cables) to link PC & DVRi

Once you have Coabis installed on your PC – connect its network cable to the DVRi – either via a cross-over cable, or by using a network hub/switch.

Set the IP address of the Coabis box to be in the same range as the DVRi.

Typically, DVRi units will have an IP of 192.168.1.serialno (i.e. serial number 37 will be 192.168.1.37) and a subnet mask of 255.255.255.0.

The coabis PC should have the same subnet and its IP address should start with 192.168.1.? – with ? being anything which is not already in use on the network – and not the same as the DVRi.

If your Coabis PC is also part of a corporate IT network – you may need to get a second network card installed – alternatively you can configure the DVRi to join the corporate network. Permission and settings must be granted by your IT manager - consult them or NETmc Marine for more advice.

The Coabis PC is connected to the Overlay by means of a **Null Modem Cable**.

Configuring the Encoder

On the encoder, run the DVRi Setup shortcut. From the DVRi set-up screen, ensure the following are set:

AddFileNo, AddSeqNo option **MUST** be checked.

Everything else **MUST** be unchecked.

The video output format and quality settings are at the discretion of the end-user.

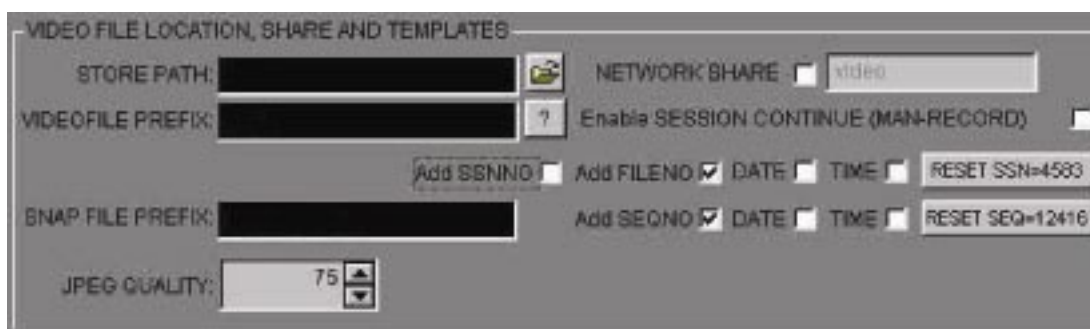

The coabis PC and the DVRi must be able to view the storage location for the digital video. Therefore, if the video being stored to the DVR is internal or caddie drive – these must be “shared” so others can see them over the network.

This is done by using the windows explorer on the DVRi and simply ‘right-clicking’ the drive you wish to share. Select “Sharing” – enable sharing and enter a share name of your choice.

When setting up paths to this location within Coabis, use the UNC naming convention – which is two back-slashes then the IP address of the unit with the share then back-slash the share name. We recommend the share name is “Coabis” e.g.

[\\192.168.1.37\coabis](http://192.168.1.37\coabis).

Configuring Coabis

1. Connect the digital video encoder following the manufacturer's instructions, and the "Configuring the Encoder" instructions above.
2. Click Tools > Digital Video Setup from the Site module menu.
3. Enter data as follows:

Digital Video Encoder: Select Mnet from the drop-down list.

IP Address: Enter the IP address of the digital video encoder.

Digital Video Encoder Connected: If the encoder is already connected, this box is checked.

4. Click Test to check the connection. If the connection fails, check that the IP address has been entered correctly, and that all the connections are securely attached.

Digital Video Configuration

Digital Video

Digital Video Encoder: NETmc
IP Address: 192.168.1.xx

Anomaly Photo Type:
 JPG
 BMP

Digital Video Encoder Connected

Test

Video Grabs

Template: VIDE0 Digital Video

Save Path

Routine Video: DV-R
\\192.168.1.xx\Video\LiveVideo\Expro\Routine\SR2007\AA\

Anomaly Video: DV-A
\\192.168.1.xx\Video\LiveVideo\Expro\Anoms\

OK



Coabis Setup

Firstly go to Baseline – Basics – Directories, and set DV-A, DV-G and DV-R as shown below.

NB: 192.168.1.xx should be replaced with the IP address of the DVRi.

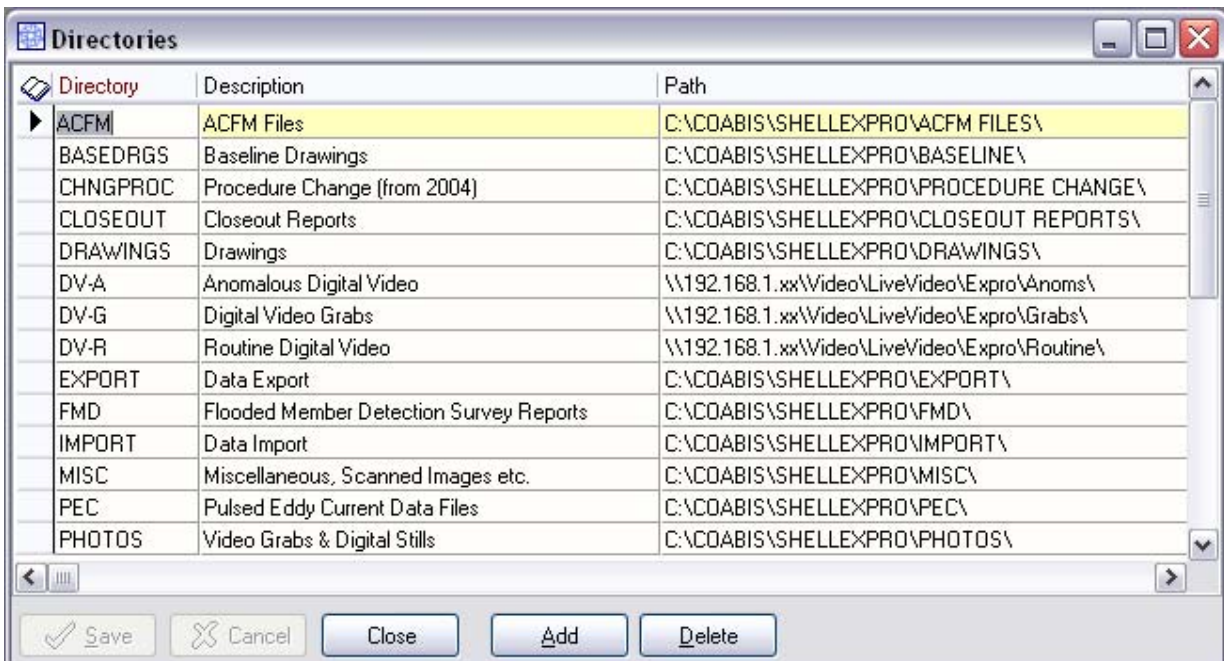

Overlay Setup

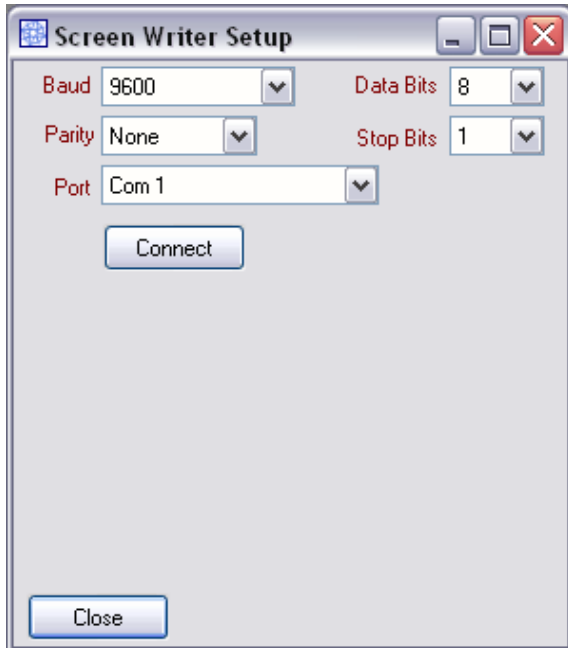
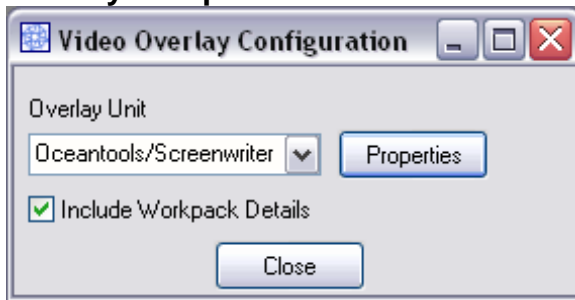

NB: If Coabis fails to connect to the overlay, try changing the Port.

Appendix v: Recording to a networked Server / NAS

Sometimes, it may be more desirable to save digital video data to a central network available storage facility – rather than storing the data locally on the DVRi (either on its internal disk or on its caddie drive).

Examples of network storage can be

- A NAS box
- A server with storage attached or in built
- Another PC on the network with a lot of storage

The setup procedure for this is:

On the network storage unit – create a shared directory where you want the video files to go.

This is typically named “Coabis”

It should contain the required 3 sub directories as defined in section v (typically “routine”, “anoms” and “grabs”)

You then configure the Coabis PC to direct video and grabs to [\\network_storage_IP\coabis](#) with the appropriate subfolder.

e.g. – if the IP of the NAS box or server is 192.168.1.1, you would enter into Coabis:

[\\192.168.1.1\coabis\anoms](#)

[\\192.168.1.1\coabis\routine](#)

[\\192.168.1.1\coabis\grabs](#)

Permissions

It is vital that the DVRi has permission to write to the NAS box or server.

The DVRi units ship with

User = Administrator

Pwd = (no password)

If the NAS or Server uses different credentials for its Administrator login, then there will be a problem and no video files will be recorded. (You may get some .ssn files, but no .mpeg and no .pkt files)

To solve this either:

- change the Administrator password on the NAS / server to blank
- or, change the logon settings of the mediaNET dispatcher on the DVRi (see next section)

Appendix vi: mediaNET dispatcher settings

To allow the DVRi to authenticate another server or storage device which does not have a logon of “DVR” password “DVR” – it may be necessary to change the mediaNET dispatcher settings on the DVRi.

On the DVRi unit – close the DVRi application – and go to the windows 2000 “Control Panel”. From the “Administrative Tools” section, open “Services”. Scroll down the list unit you get to “mediaNET dispatcher”

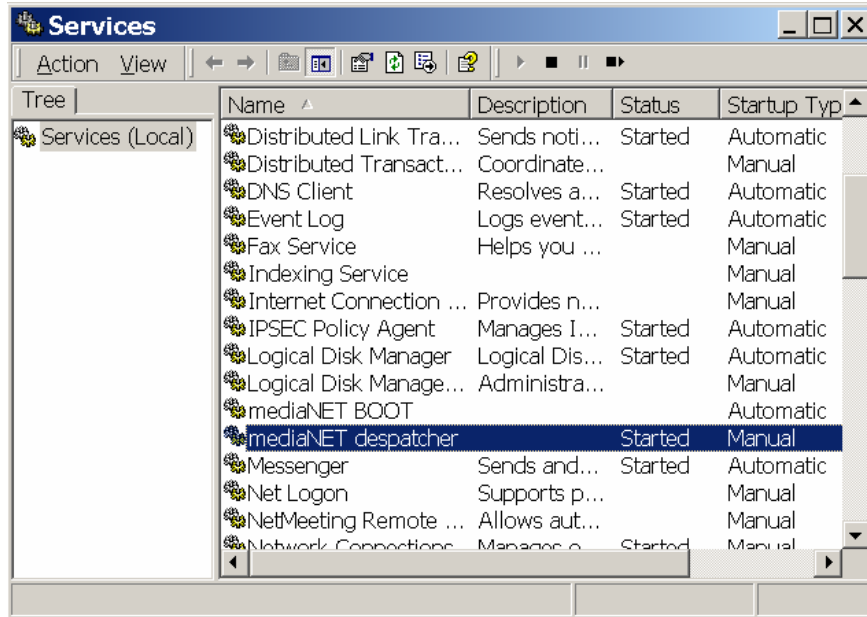

Right click on the mediaNET dispatcher line and select “Properties”. From the tabs – select “Log On”

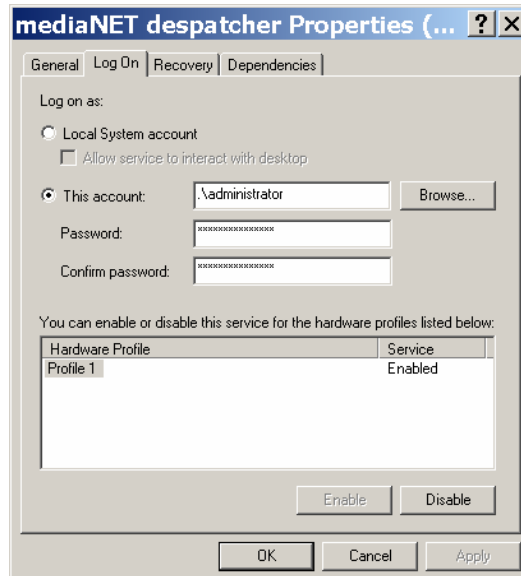

Select the use “This Account” option – and enter the account username and password information which is authenticated to your remote storage device.

OK and accept these changes – and reboot the DVRi system. This will now successfully log to the remote device.

Appendix vii: Real time file duplication

If network connections are not reliable – or if a user wishes to save data to 2 different locations simultaneously – it may be desirable to record video data to the local caddie drive on the DVRi – and also to another location on the network.

mediaNET despatcher can only log to 1 location at a time – but using other 3rd party tools – file synchronisation can be done between the DVRi and another storage device.

We can verify and confirm correct operation of these tools with our software and systems – currently, the products we have tested and are happy with are:

Robocopy

If you use any other utility, we will not be able to support you – so take care in your selection if you do not have IT support elsewhere.

Use of Robocopy:

You should download or be supplied a copy of Robocopy by our integrator.
Copy it to a directory on the DVRi (e.g. c:\robocopy)

Create a .cmd file and configure it to run in the “startup” folder of windows.
The contents of the .cmd file should be:

```
start " DV Sync" /min /low robocopy c:\video \\NAS_IP\backup /s /xo /m /mot:5 /mon:1 /tee /np  
/log+:c:\coabis\sync_log.txt /xf sync_log.txt
```

**where c:\video is the path on the DVRi where the raw video is being initially saved and
\\NAS_IP\backup is the share on the remote system where the data is being replicated**

Robocopy.exe and sync.cmd can be downloaded from our website
www.netmcmarine.co.uk/file_downloads.htm

Appendix viii: Example Coabis interfacing diagrams

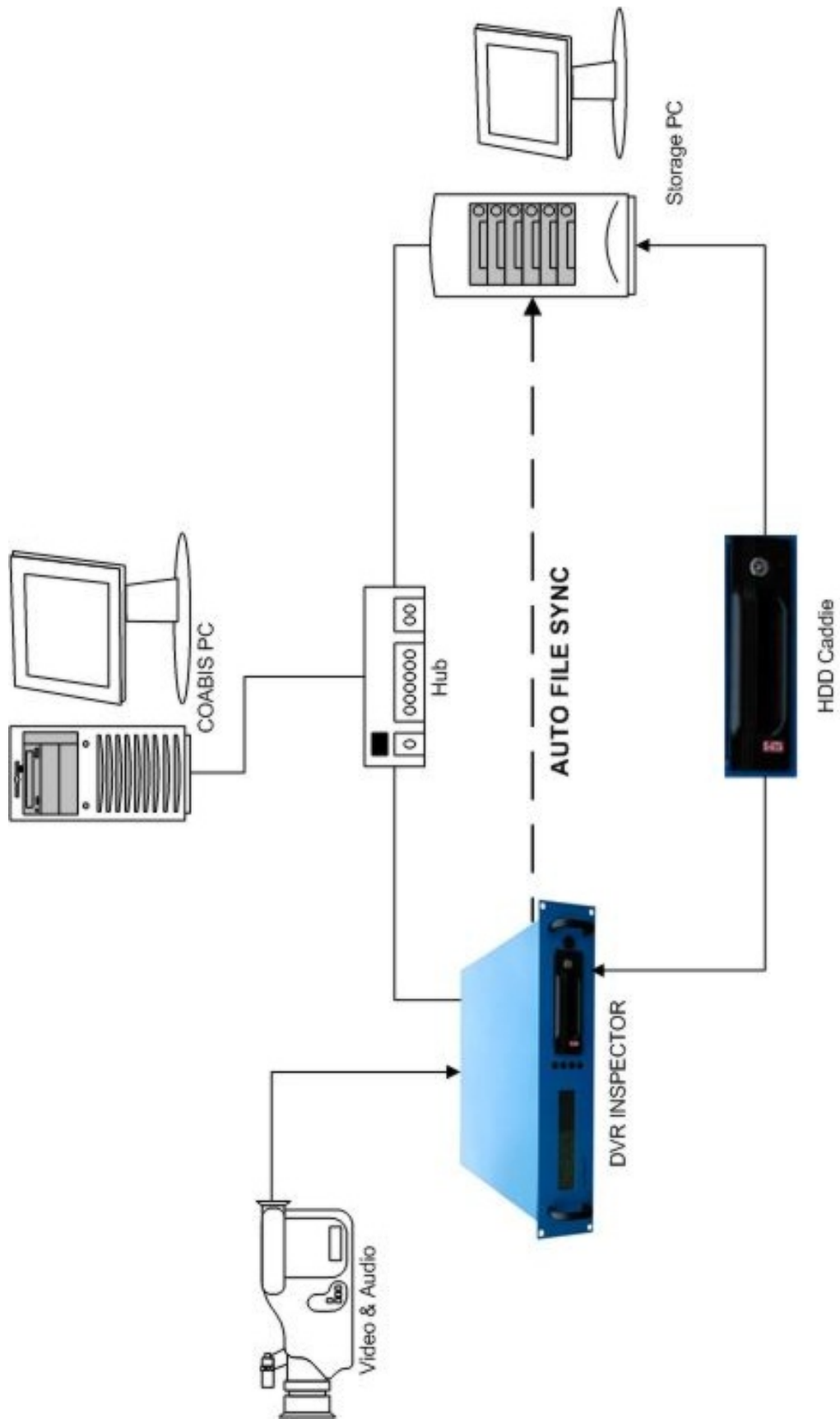

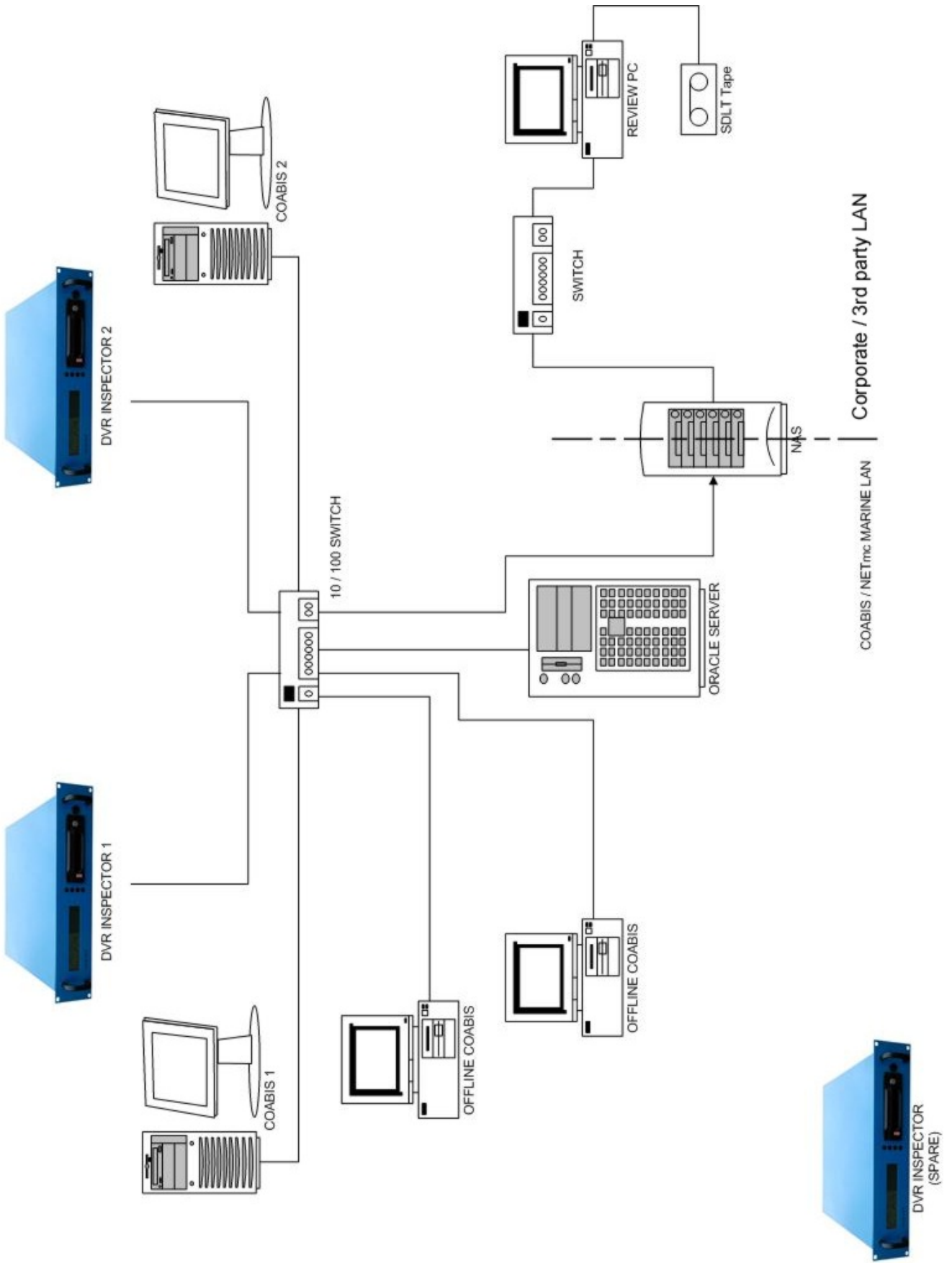

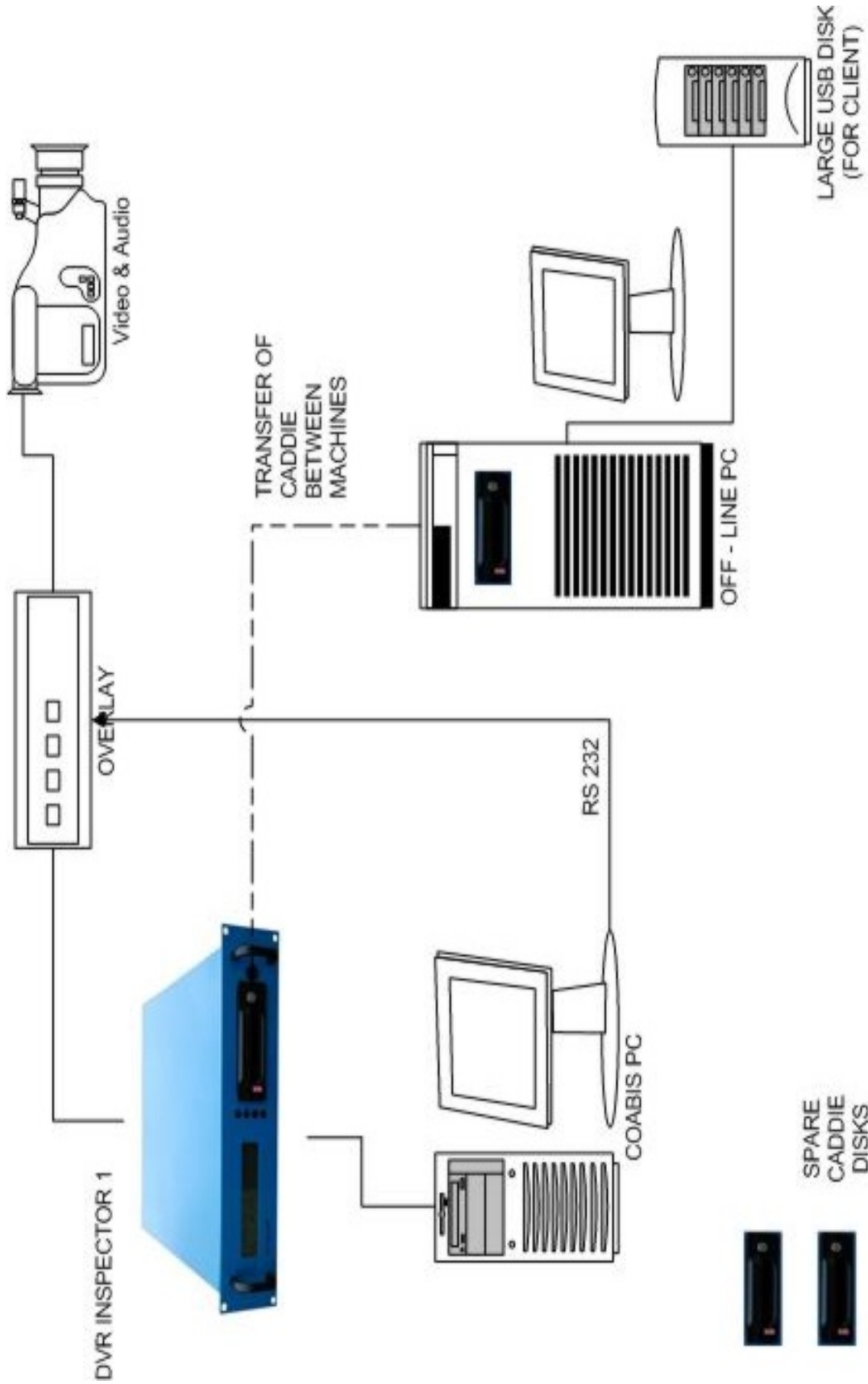

Appendix ix: Integrated Overlay configuration

Rackmount DVR Inspectors

DVRi units can now be shipped with optional integrated overlay / screenwriter.

The overlay is physically fitted inside the DVRi removing the need for a separate physical unit and minimizing rack space required. But it is treated as a separate entity - with the connectors presented externally – which allows the user to by-pass the overlay if required.

The DVRi overlay is a 2 data input system – and **only 2 data inputs** are possible at any one time e.g:

- Overlay Manager and NAV, or
- NAV and Inspection Data, or
- Inspection DATA and CP
- etc

Connections

Whichever data input system is used, in order to enable overlay – the input video signal should be first routed to “Overlay In” – and then from ‘Overlay Out’ to the regular video input to the DVRi (using the supplied BNC to BNC cable).

Latest DVR Versions



Null modem cable from NAV or inspection PC should be plugged into either of the overlay data ports on the bottom row of connectors

Connect video input here
Composite Video with Overlay

Older versions of DVRis

NOTE: Earlier DVRi units may have different connector layouts on the top row – the output from the overlay should be connected to the composite video input BNC.



Null modem cable from NAV or inspection PC should be plugged into either of the overlay data ports on the bottom row of connectors

Connect video input here
Composite Video with Overlay

DVR Peli

If internal overlay is fitted in a DVR Peli, the data channel 1 is permanently internally wired to the DVRi motherboard for use by Overlay Manager.

Only 1 external overlay data input is offered – this is the only serial connector on the top panel.



The video signal is also permanently routed via the overlay so there is no need for a BNC jumper cable as described above.

Overlay Commands

The overlay characters are generated by either using the Overlay Manager software from the DVRi screen – or by injecting serial commands into one of the overlay serial ports on the back of the DVRi. Typically, this will be a cable to a Coabis, Scope or E-Inspect workstation on Serial 1 – while Serial 2 might be reserved for CP or other information.

The cable used should be a 9way female to 9way female NULL modem cable.

The wiring is as follows:

<u>Serial port</u>	<u>Overlay Serial Input</u>
2	3
3	2
5	5

When using Coabis – from Site. tools, video overlay:

- Use Screenwriter
- Baud = 9600
- Parity = none
- Databits = 8
- Stopbits = 1
- Com Port = port used on the coabis PC

The internal overlay command structure follows the established industry standards – which can be summarised as:

Function	Hex Code	Dec Code	Key Code
Clear Screen	10	16	^P
Cursor Right	11	17	^Q
Cursor Up	12	18	^R
Cursor Down	13	19	^S
Cursor Left	14	20	^T
Home Cursor	15	21	^U
Line Feed	0A	10	^J
Carriage return	0D	13	^M

Overlay Manager

The overlay manager software may auto launch when the systems starts – and can be minimized (by clicking mini mode) when not in use (a shortcut for overlay manager will be on the desktop if closed in error).

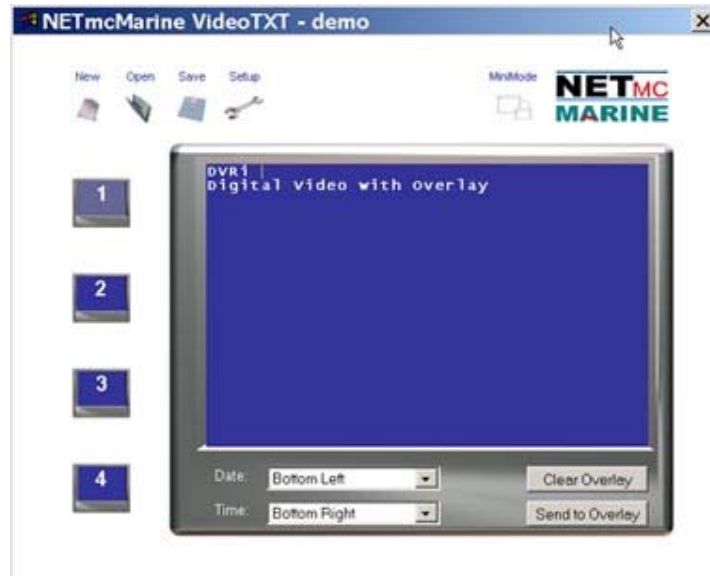

The software allows insertion of time / date and any text.

Up to 4 pages of text can be configured and available for quick recall – by pressing the appropriate screen number. Pages can also be saved and opened – allowing for preset client specific configurations.

Overlay manager requires a link between the serial port of the DVRi and the chosen serial input of the overlay. A short cable has been supplied with the system – but a 'null modem' cable will be suitable.

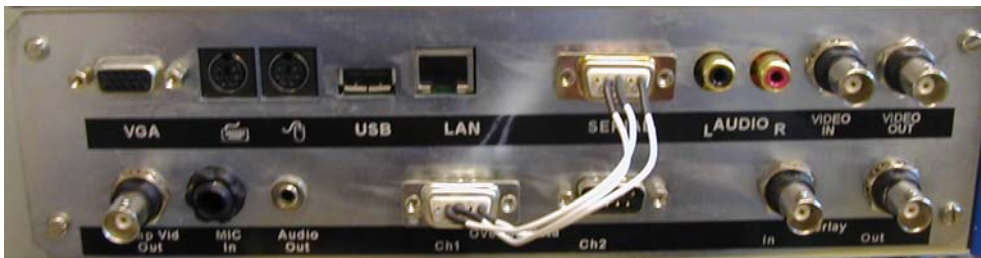

Note: In older versions of the DVRi the Overlay Manager is wired **internally** to Serial Port 1. In this case only one further data input string can be sent externally (to Port 2).

In **DVR Pelis** the Overlay Manager is always wired internally.

A typical time, date and header overlay:



If the overlay text is jumpy, the genloc is having trouble syncing to the input video signal. Check connections and signal levels (poor switchers etc). Line conditioning may be required if the video source is a VCR as their output is not generally compliant.

Reset

If the overlay does not perform as expected (due for example to experiments with different input strings) it may need resetting.

To reset the internal overlay it is necessary to **POWER CYCLE** the whole DVRi: i.e. the user will need to switch the DVR off, wait a few seconds, and then switch it on again. A Windows reboot will not work.

Appendix x: Units with SDI input

Rear panel

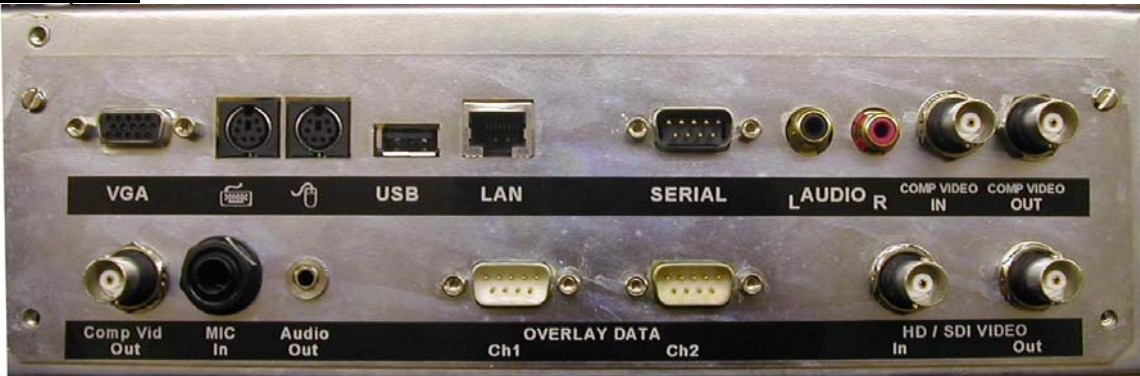

Video input can be either composite (via BNC on top row of connectors) or HD-SDI (bottom connectors). **NOTE: Only 1 type of input should be connected at a time.**

SDI units have a SDI pass-through connector, which can be used to pass the input video to a high-resolution monitor etc.

SDI units also have a different setup page – see the screen grab below.

The screenshot shows the 'INSPECTOR - SETUP' window. It is divided into several sections: APPLICATION (checkboxes for keyboard shortcuts, always on top, and preview), DEVICE (fields for device address and livestream on), FORMAT (radio buttons for MPEG 1, 2, 4), SOURCE (radio buttons for BNC and SDI), PAL/NTSC, QUALITY (radio buttons for MPEG1 and MPEG2 with sub-options like LOW, MED, HIGH, SUPER), VIDEO STORAGE FORMAT (radio buttons for MPEG ONLY and PKT WITH EMBEDDED NAV), MAXIMUM SEGMENT SIZE (fields for duration and size), VIDEO FILE LOCATION, SHARE AND TEMPLATES (fields for store path, clip path, still path, and various checkboxes for SSNNO, FILENO, DATE, TIME), and BLACK BOX SETTINGS (an edit button). At the bottom are buttons for APPLY, RESET, and CLOSE.

SDI units have internally connected overlay which is permanently in the circuit (unlike the BNC units which use external jumpering.)

Note:

This equipment has been tested and found to comply with the limits for a Class A digital device, pursuant to part 15 of the FCC Rules. These limits are designed to provide reasonable protection against harmful interference when the equipment is operated in a commercial environment. This equipment generates, uses, and can radiate radio frequency energy and, if not installed and used in accordance with the instruction manual, may cause harmful interference to radio communications. Operation of this equipment in a residential area is likely to cause harmful interference in which case the user will be required to correct the interference at his own expense.

End of Document

Note: Whilst every effort has been made to ensure that the information contained in this manual is accurate, no liability can be accepted for errors and omissions.